



# Encoder

## User's Manual







# Foreword

## General

This manual introduces the functions and operations of the Encoder (hereinafter referred to as "the Device").

## Safety Instructions

The following categorized signal words with defined meaning might appear in the manual.

Signal Words	Meaning
 DANGER	Indicates a high potential hazard which, if not avoided, will result in death or serious injury.
 WARNING	Indicates a medium or low potential hazard which, if not avoided, could result in slight or moderate injury.
 CAUTION	Indicates a potential risk which, if not avoided, could result in property damage, data loss, lower performance, or unpredictable result.
 TIPS	Provides methods to help you solve a problem or save you time.
 NOTE	Provides additional information as the emphasis and supplement to the text.

## Revision History

Version	Revision Content	Release Time
V1.0.1	Modify model.	July 2024
V1.0.0	First release.	March 2024

## About the Manual

- The manual is for reference only. If there is inconsistency between the manual and the actual product, the actual product shall prevail.
- We are not liable for any loss caused by the operations that do not comply with the manual.
- The manual would be updated according to the latest laws and regulations of related jurisdictions. For detailed information, refer to the paper manual, CD-ROM, QR code or our official website. If there is inconsistency between paper manual and the electronic version, the electronic version shall prevail.

- All the designs and software are subject to change without prior written notice. The product updates might cause some differences between the actual product and the manual. Please contact the customer service for the latest program and supplementary documentation.
- There still might be deviation in technical data, functions and operations description, or errors in print. If there is any doubt or dispute, we reserve the right of final explanation.
- Upgrade the reader software or try other mainstream reader software if the manual (in PDF format) cannot be opened.
- All trademarks, registered trademarks and the company names in the manual are the properties of their respective owners.
- Please visit our website, contact the supplier or customer service if there is any problem occurring when using the device.
- If there is any uncertainty or controversy, we reserve the right of final explanation.

# Important Safeguards and Warnings

This section introduces content covering the proper handling of the device, hazard prevention, and prevention of property damage. Read carefully before using the device, comply with the guidelines when using it, and keep the manual safe for future reference.

## Operation Requirements



- Make sure that the power supply of the device works properly before use.
- Transport, use and store the device under allowed humidity and temperature conditions.
- Prevent liquids from splashing or dripping on the device. Make sure that there are no objects filled with liquid on top of the device to avoid liquids flowing into it.
- Do not disassemble the device.

## Installation Requirements



### **WARNING**

- Strictly abide by local electrical safety standards, and make sure that the voltage in the area is steady and conforms to the power requirements of the device.
- Do not connect the device to more than one power supply. Otherwise, the device might become damaged.



- Observe all safety procedures and wear required protective equipment provided for your use while working at heights.
- Do not expose the device to direct sunlight or heat sources.
- Do not install the device in humid, dusty or smoky places.
- Install the device in a well-ventilated place, and do not block the ventilator of the device.

## Maintenance Requirements



- Use the accessories suggested by the manufacturer. Installation and maintenance must be performed by qualified professionals.
- Clean the device with a soft dry cloth or a clean soft cloth dipped in neutral detergent.
- Contact your local dealer or the service center nearest to you if the device needs internal configuration or maintenance. Do not dismantle or modify the device without a qualified professional present to avoid the risk of danger or damage to the device. We will assume no responsibility for any problems caused by unauthorized modifications or maintenance.

# Table of Contents

<b>Foreword.....</b>	<b>II</b>
<b>Important Safeguards and Warnings.....</b>	<b>IV</b>
<b>1 Product Information.....</b>	<b>1</b>
1.1 Introduction.....	1
1.2 Features.....	1
1.3 Dimensions.....	2
1.4 Structure.....	3
1.5 Function Key Description.....	4
<b>2 Technical Information .....</b>	<b>6</b>
<b>3 Device Operation.....</b>	<b>7</b>
3.1 Packing List.....	7
3.2 Operation Steps.....	7
<b>4 FAQ .....</b>	<b>10</b>
<b>5 Maintenance .....</b>	<b>11</b>
<b>Appendix 1 Cybersecurity Recommendations.....</b>	<b>12</b>

# 1 Product Information

## 1.1 Introduction

DHI-HY-BM-1712 Encoder is designed to read/write logic address of smoke detector, heat detector, manual call point, modules, and gas detectors. It is convenient to bring in the work place and easy to operate.

## 1.2 Features

- Automatically address +1 when addressing devices consecutively.
- After writing the address successfully, there will be a "Di" tone. If the writing fails, "Failure" is displayed.
- Device statistics: Support device statistics for the entire bus system and display them in charts to enhance debugging efficiency.
- Start/stop: Support device start/stop test.
- Line Troubleshooting: Measure line voltage and resistance for various purposes.
- Low-power sleep: Intelligent shutdown without operation for a long time.
- Portable and miniature design: Easy to carry and operate, flexible in use.
- Functional keys with sound: Press any key to light up the LCD screen.
- LCD display: Intuitive and user-friendly screen to write/read address. LCD backlight function enables users to operate in dark environments.

## 1.3 Dimensions

Figure 1-1 Dimension [mm (inch)]

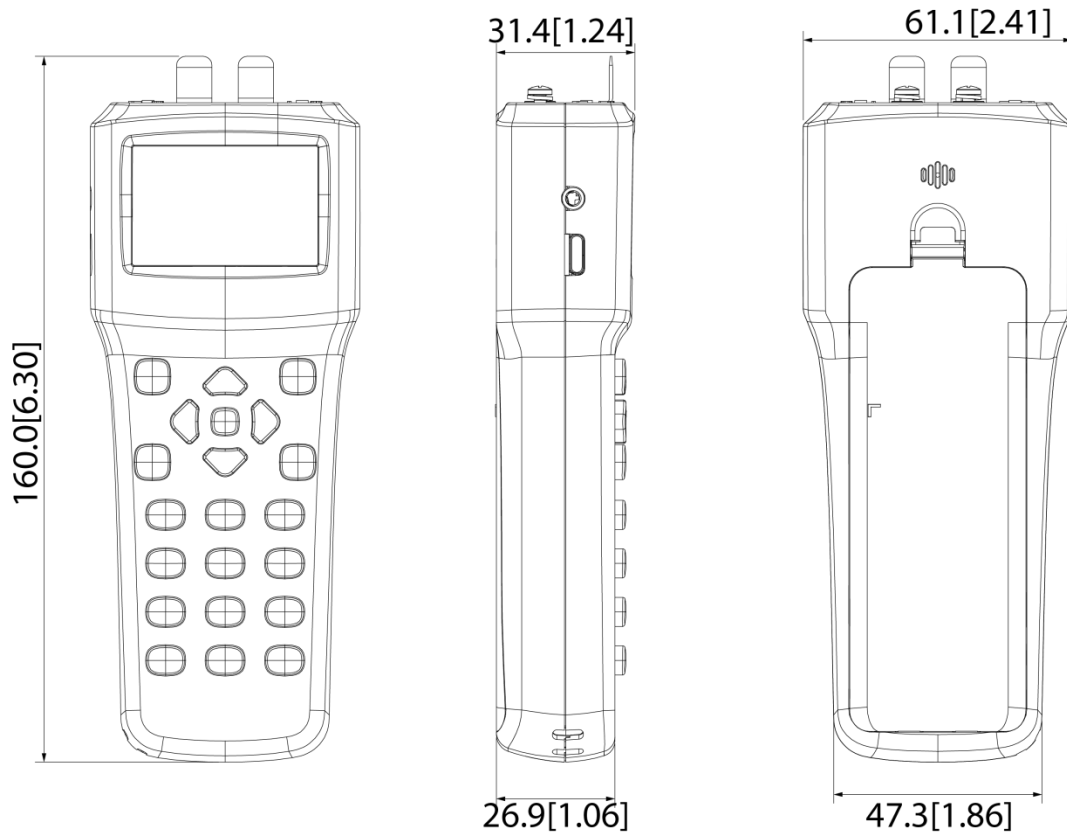

## 1.4 Structure

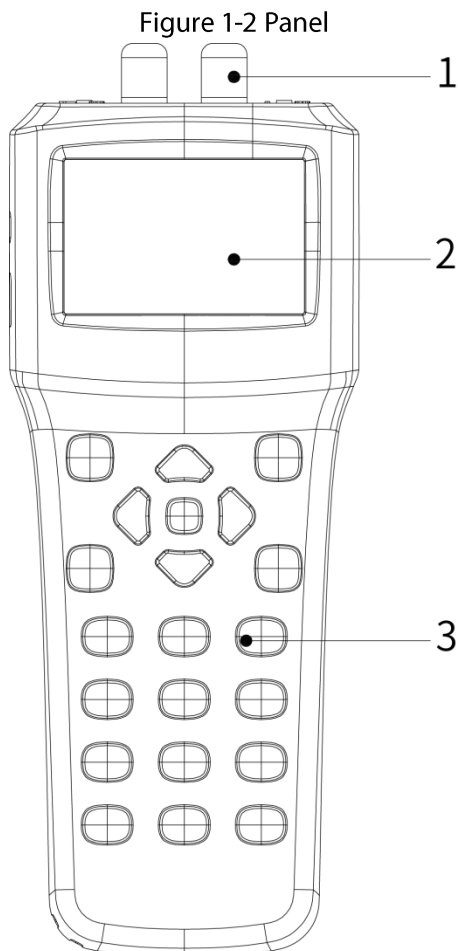















Table 1-1 Panel introduction

No.	Name	Introduction
1	Metal plug	Align detectors.
2	LCD screen	-
3		Add 1.
		Minus 1.
		Switch to the left page.
		Switch to the right page.
		Press  , display the read logic address of the device.
		Press  , display the write logic address of the device. If the writing fails, "Failure" is displayed.

		Press to power on/off device. <ul style="list-style-type: none"> <li>• When the encoder is turned off, press the button to turn on the encoder.</li> <li>• When the encoder is turned on, press the button for 3 seconds to turn off the encoder.</li> </ul>
		Press to light up the LCD screen.
		Press to clear operation.
		Press to return to the previous operation interface.
		Press to confirm operation.
	0-9	Enter numeric values.  NOTE The address value is from 1 to 254.

## 1.5 Function Key Description

### Read & Write

Read and write the logic addresses of Wisualarm fire alarm devices, including smoke detectors, heat detectors, sounder strobes, manual call points, modules, gas detectors, door sensors, electric door closers, residual current detectors, and voltage/current sensors.

### Debug

Debug node devices, including device statistics, details display, start & stop, linear beam debugging, broadcasting test, smoke & temperature sensor reading, voltage detection, and resistance measurement.

- Device statistics: After connecting to the signal bus, execute the device statistics command to count the number of fire alarm devices on the signal bus, and display them in charts.



**CAUTION**

Due to high power consumption, it is necessary to use a portable charger for power supply.

- Details display: Read and modify user codes and parameters of node devices.
- Start & stop: After connecting to the signal bus, execute the equipment start/stop command to start/stop the output equipment on the signal line, which is convenient for debugging.
- Linear beam debugging: Turn on the linear beam laser to provide power for laser calibration debugging and automatic beam calibration.
- Broadcasting test: Before connecting the broadcast line to the amplifier, use an encoder to inspect the broadcast line.

- Smoke sensor reading: Read the smoke concentration of the smoke sensor.
- Temperature sensor reading: Read the temperature of the temperature sensor.
- Voltage detection: Detect the voltage of the circuit with a detection range of DC 0~48V.



WARNING

Prohibit connecting voltage greater than 48V.

- Resistance measurement: Measure the resistance between signal lines and between lines and ground.



WARNING

It is prohibited to use this function when the circuit is live.

## Device setting

Set the screen brightness level and sleep & standby mode of the encoder.

## Device query

Query the encoder power and version.

## 2 Technical Information

Parameter	Introduction
Electrical	
Working Power	DC 6V
Current	<ul style="list-style-type: none"> <li>• Monitoring current: ≤ 1.5mA</li> <li>• Operating current: ≤ 60mA</li> </ul>
Output Voltage	DC 16V or DC 24V
Environment	
Operating Temperature	-10°C to +55°C (+14°F to +131°F)
Storage Temperature	-20°C to +65°C (-4°F to +149°F)
Operating Humidity	≤ 95% RH (no condensation)
Construction	
Color	White
Dimensions	47.3 mm × 160.0 mm × 31.4 mm (1.86" × 6.30" × 1.24")
Weight	167 g (0.37 lb)

# 3 Device Operation

## 3.1 Packing List

Check the quantity and model. If you find device damage or any loss, contact the after-sales service.

## 3.2 Operation Steps

Step 1 Connect the power supply.

- Connect TYPE-C interface and power with a USB data cable.
- Remove the battery compartment cover and insert dry batteries. Close the battery cover and press down until it clicks into place.

 **CAUTION**

Please make sure the battery's positive and negative poles are put correctly.

Figure 3-1 Power supply

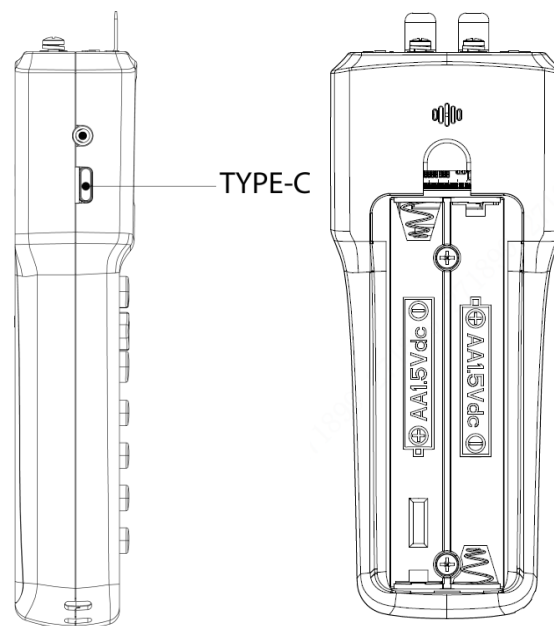

Step 2 Plug alligator clips into jack socket and connect them with the device terminals.

Figure 3-2 Alligator clip

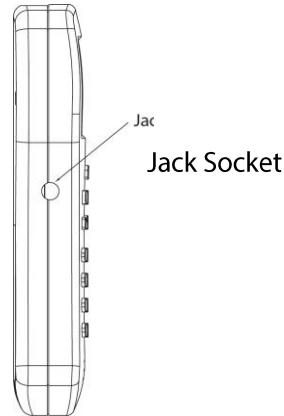

**Step 3** Press  to power on encoder.

- Connect the output terminal of alligator clip and the 1 and 2 terminals of node detector.
- Align the metal plug provided at the front end to connect terminals 1 and 2 of the node detector.

**Step 4** Make the device encoded according to the device address

1) Press , to read the logic address of the devices. After reading the address successfully, the logic address appears on the interface with a "Di" tone.

1) Press , to enter the writing information. The logic address appears on the

interface and press  to confirm the writing. After writing the address successfully, there will be a "Di" tone, and the logic address will automatically add 1 for next writing.

2) Encode next device.

 **CAUTION**

- When using battery power supply, if the USB power supply is adopted, the power supply mode will be switched to USB power supply; if the USB data cable is pulled out, the encoder will shut down.
- When using the USB power supply, it is recommended to use a standard TYPE-C5V power supply cable. The input voltage of the USB port should not exceed 6.5V.

Figure 3-3 Coding

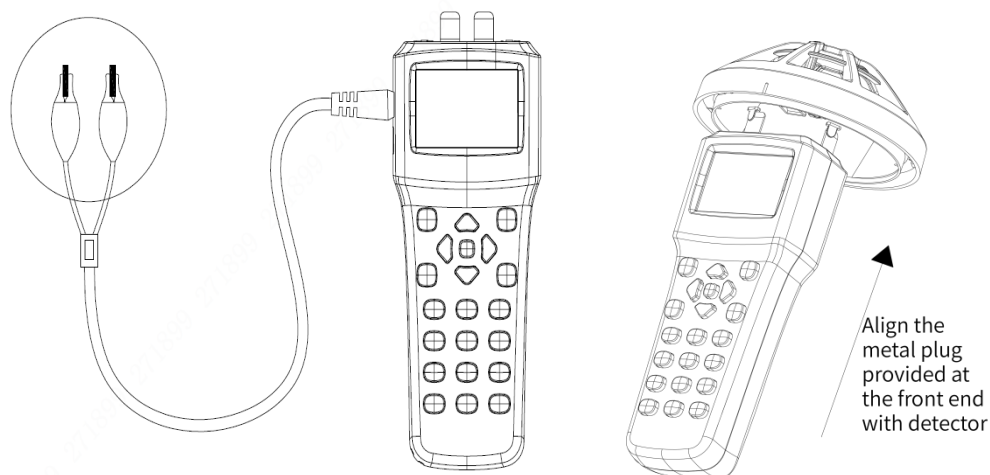

## 4 FAQ

<b>Problem</b>	<b>Solutions</b>
Fails to start up	Maker sure the power is sufficient.
Unable to encode	<ul style="list-style-type: none"><li>• Lose contact with the device. Check the connection of alligator clips.</li><li>• Confirm whether the address is within 254.</li><li>• Check the normal operation of encoded device.</li></ul>

## 5 Maintenance

If the encoder is not used for a long time, it is recommended to remove the battery.

# Appendix 1 Cybersecurity Recommendations

Cybersecurity is more than just a buzzword: it's something that pertains to every device that is connected to the internet. IP video surveillance is not immune to cyber risks, but taking basic steps toward protecting and strengthening networks and networked appliances will make them less susceptible to attacks. Below are some tips and recommendations from Dahua on how to create a more secured security system.

## **Mandatory actions to be taken for basic device network security:**

### **1. Use Strong Passwords**

Please refer to the following suggestions to set passwords.

- The length should not be less than 8 characters.
- Include at least two types of characters; character types include upper and lower case letters, numbers and symbols.
- Do not contain the account name or the account name in reverse order.
- Do not use continuous characters, such as 123, abc, etc.
- Do not use overlapped characters, such as 111, aaa, etc.

### **2. Update Firmware and Client Software in Time**

- According to the standard procedure in Tech-industry, we recommend to keep your device (such as NVR, DVR, IP camera, etc.) firmware up-to-date to ensure the system is equipped with the latest security patches and fixes. When the device is connected to the public network, it is recommended to enable the "auto-check for updates" function to obtain timely information of firmware updates released by the manufacturer.
- We suggest that you download and use the latest version of client software.

## **"Nice to have" recommendations to improve your device network security:**

### **1. Physical Protection**

We suggest that you perform physical protection to device, especially storage devices. For example, place the device in a special computer room and cabinet, and implement well-done access control permission and key management to prevent unauthorized personnel from carrying out physical contacts such as damaging hardware, unauthorized connection of removable device (such as USB flash disk, serial port), etc.

### **2. Change Passwords Regularly**

We suggest that you change passwords regularly to reduce the risk of being guessed or cracked.

### **3. Set and Update Passwords Reset Information Timely**

The device supports password reset function. Please set up related information for password reset in time, including the end user's mailbox and password protection questions. If the information changes, please modify it in time. When setting password protection questions, it is suggested not to use those that can be easily guessed.

### **4. Enable Account Lock**

The account lock feature is enabled by default, and we recommend you to keep it on to guarantee the account security. If an attacker attempts to log in with the wrong password several times, the corresponding account and the source IP address will be locked.

### **5. Change Default HTTP and Other Service Ports**

We suggest you to change default HTTP and other service ports into any set of numbers

between 1024–65535, reducing the risk of outsiders being able to guess which ports you are using.

#### **6. Enable HTTPS**

We suggest you to enable HTTPS, so that you visit Web service through a secure communication channel.

#### **7. MAC Address Binding**

We recommend you to bind the IP and MAC address of the gateway to the device, thus reducing the risk of ARP spoofing.

#### **8. Assign Accounts and Privileges Reasonably**

According to business and management requirements, reasonably add users and assign a minimum set of permissions to them.

#### **9. Disable Unnecessary Services and Choose Secure Modes**

If not needed, it is recommended to turn off some services such as SNMP, SMTP, UPnP, etc., to reduce risks.

If necessary, it is highly recommended that you use safe modes, including but not limited to the following services:

- SNMP: Choose SNMP v3, and set up strong encryption passwords and authentication passwords.
- SMTP: Choose TLS to access mailbox server.
- FTP: Choose SFTP, and set up strong passwords.
- AP hotspot: Choose WPA2-PSK encryption mode, and set up strong passwords.

#### **10. Audio and Video Encrypted Transmission**

If your audio and video data contents are very important or sensitive, we recommend that you use encrypted transmission function, to reduce the risk of audio and video data being stolen during transmission.

Reminder: encrypted transmission will cause some loss in transmission efficiency.

#### **11. Secure Auditing**

- Check online users: we suggest that you check online users regularly to see if the device is logged in without authorization.
- Check device log: By viewing the logs, you can know the IP addresses that were used to log in to your devices and their key operations.

#### **12. Network Log**

Due to the limited storage capacity of the device, the stored log is limited. If you need to save the log for a long time, it is recommended that you enable the network log function to ensure that the critical logs are synchronized to the network log server for tracing.

#### **13. Construct a Safe Network Environment**

In order to better ensure the safety of device and reduce potential cyber risks, we recommend:

- Disable the port mapping function of the router to avoid direct access to the intranet devices from external network.
- The network should be partitioned and isolated according to the actual network needs. If there are no communication requirements between two sub networks, it is suggested to use VLAN, network GAP and other technologies to partition the network, so as to achieve the network isolation effect.
- Establish the 802.1x access authentication system to reduce the risk of unauthorized access to private networks.

- Enable IP/MAC address filtering function to limit the range of hosts allowed to access the device.

## More information

Please visit Dahua official website security emergency response center for security announcements and the latest security recommendations.

ENABLING A SAFER SOCIETY AND SMARTER LIVING

ZHEJIANG DAHUA VISION TECHNOLOGY CO., LTD.

Address: No.1199 Bin'an Road, Binjiang District, Hangzhou, P. R. China | Website: [www.dahuasecurity.com](http://www.dahuasecurity.com) | Postcode: 310053

Email: [overseas@dahuatech.com](mailto:overseas@dahuatech.com) | Fax: +86-571-87688815 | Tel: +86-571-87688883