

# DH-IPC-PDBW82041-B360-S2

## 4 × 5 MP 4-Directional Panoramic Dome Wizmind Network Camera



**WizMind**

Launched by Dahua Technology, Dahua WizMind is a full portfolio of solutions composed of project-oriented products including IPC, IVSS, NVR, PTZ, XVR, Thermal and software platform which adopts industry-leading deep learning algorithms. Focusing on customer's requirements, WizMind provides precise, reliable and comprehensive AI solutions for verticals.

### Series Overview

Designed to be highly flexible, the Non-Splicing Camera performs surveillance in multiple directions for wide scenes through its adjustable lens, making it ideal for use with multiple cameras. It is easy to install and supports a variety of functions, such as face detection, people counting and perimeter protection. The camera is widely used in scenes such as warehouses, transit stations and campuses.

### Functions

#### Perimeter Protection

With deep learning algorithm, Dahua Perimeter Protection technology can recognize human and vehicle accurately. In restricted area (such as pedestrian area and vehicle area), the false alarms of intelligent detection based on target type (such as tripwire, intrusion, fast moving, parking detection, loitering detection and gathering detection) are largely reduced.

#### People Counting

With deep learning algorithm, Dahua People Counting technology can track and process moving human body targets to realize the accurate statistics of enter No., leave No., and In Area No. Working with management platform, it outputs reports to meet your requirements.

#### Face Detection

Dahua Face Detection technology can detect the face in the image. With deep learning algorithm, the technology supports detecting, tracking, capturing and selecting the best face image, and then outputs face snapshot.

- Four 5-MP 1/2.7" CMOS image sensor, low illuminance, high image definition.
- 4-channel stream output, and each channel can output max. 5 MP (2592 × 1944) @25/30 fps.
- ROI, SMART H.264+/H.265+, flexible coding, applicable to various bandwidth and storage environments.
- The intelligent functions of 4 channels can be enabled at the same time, including face detection, IVS, and people counting.
- Intelligent detection: Tripwire, intrusion, fast moving (the three functions support the classification and accurate detection of vehicle and human), abandoned object, missing object, loitering detection, people gathering, and parking detection.
- FlexStream: The 4 channels of images can be viewed in a defined channel with 1 channel stream. That is the multiple images can be displayed in 1 channel.
- Web5.0 interface design, which is friendly to users, and easy for operation.
- Built-in IR LED illuminator, and the max. illumination distance is 30 m.
- Alarm: 3 in, 2 out; audio: 1 in, 1 out; RS-485; supports max. 256 G Micro SD card.
- 12 VDC/PoE power supply; 12 VDC power output, and max. current 165mA; easy for installation.
- IP67 and IK10 protection.
- Anti-corrosion protection (optional).



### One IP Address for Multiple Streams

With one IP address, Dahua multi-sensor camera can display multiple images. The camera can do multi-image monitoring through software platform or NVR.

**Technical Specification**

**Camera**

Image Sensor	Channel 1-4: 1/2.7" CMOS
Max. Resolution	Channel 1-4: 2592 (H) × 1944 (V)
ROM	8 GB
RAM	4 GB
Scanning System	Progressive
Electronic Shutter Speed	Auto/Manual 1/3 s-1/100,000 s
Min. Illumination	Channel 1-4: 0.005 lux@F1.7 (Color,30 IRE); 0.0005 lux@F1.7 (B/W,30 IRE); 0 lux (Illuminator on)
S/N Ratio	>56dB
Illumination Distance	30 m (98.43 ft) (IR LED)
Illuminator On/Off Control	Auto;Manual
Illuminator Number	8 (IR LED)
Pan/Tilt/Rotation Range	Channel 1-4: Pan: 0°-360° Tilt: 0°-75° Rotation: 0°-355°

**Lens**

Lens Type	Channel 1-4: Motorized vari-focal
Lens Mount	Channel 1-4: φ14
Focal Length	Channel 1-4: 2.8 mm-12 mm
Max. Aperture	Channel 1-4: F1.7
Field of View	Channel 1-4: H: 100°-42°; V: 74°-32°; D: 133°-53°
Iris Control	Fixed
Close Focus Distance	Channel 1-4: 0.8 m (2.62 ft)

	Detect	Observe	Recognize	Identify
DORI Distance	66 m-140.4 m (216.54 ft-460.63 ft)	26.4 m-56.1 m (86.61 ft-184.06 ft)	13.2 m-28.8 m (43.31 ft-94.49 ft)	6.6 m-14 m (21.65 ft-45.93 ft)
	*DORI (Detect, Observe, Recognize, Identify) is a standard system (EN-62676-4) for defining the ability of a person viewing the video to distinguish persons or objects within a covered area. The numbers in this table do not reflect intelligent function distances. For intelligent function distances, refer to installation and commissioning manual/project design tool.			

**Smart Event**

IVS	Abandoned object; missing object
-----	----------------------------------

**Intelligence**

IVS (Perimeter Protection)	Tripwire; intrusion; fast moving (the three functions support the classification and accurate detection of vehicle and human); loitering detection; people gathering; parking detection
----------------------------	---

Face Detection	Face detection; track; snapshot; snapshot optimization; optimal face snapshot upload; face enhancement; face exposure; face attributes extraction including 6 attributes (gender, age, glasses, expressions, mask, and beard) and 8 expressions (angry, sad, disgusted, scared, surprised, calm, happy, confused); face snapshot set as face or one-inch photo; snapshot strategies (real-time snapshot, quality priority and optimization snapshot); face angle filter; optimization time setting.
People Counting	Tripwire people counting and people counting in area; generating and exporting report (day/month/year); queue management and exporting report (day/month); 4 rules can be set for tripwire, people counting in area and queue management.
Smart Search	Work together with Smart NVR to perform refine intelligent search, event extraction and merging to event videos.

**Video**

Video Compression	H.265; H.264; H.264H; H.264B; MJPEG (only supported by the sub stream)
Smart Codec	Smart H.265+; Smart H.264+
Video Frame Rate	Channel 1: Main stream: 2592 × 1944@(1-25/30 fps) Sub stream: 1920 × 1080@(1-25/30 fps) Third stream: Single Stream mode:1920 × 1080@(1-25/30 fps) Flex Stream mode:3296 × 2472@(1-25/30 fps) Channel 2-4: Main stream: 2592 × 1944@(1-25/30 fps) Sub stream: 1920 × 1080@(1-25/30 fps) Third stream:1920 × 1080@(1-25/30 fps)
Stream Capability	3 streams
Resolution	Single Stream: 5M (2592 × 1944); 2560 × 1440; 3M (2048 × 1536); 2304 × 1296; 1080p (1920 × 1080); 1.3M (1280 × 960); 720p (1280 × 720); D1 (704 × 576/704 × 480); VGA (640 × 480); CIF (352 × 288/352 × 240); Flex Stream: 8M (3296 × 2472); 5M (2592 × 1944); UXGA (1600 × 1200); 1080p (1920 × 1080); 1.3M (1280 × 960); D1 (704 × 576/704 × 480); VGA (640 × 480); CIF (352 × 288/352 × 240)
Bit Rate Control	CBR/VBR
Video Bit Rate	H.264: 32 kbps-17152kbps H.265: 12 kbps-10240 kbps
Day/Night	Auto(ICR)/Color/B/W
BLC	Yes
HLC	Yes
WDR	DWDR
White Balance	Auto; natural; street lamp; outdoor; manual; regional custom
Gain Control	Auto;Manual
Noise Reduction	3D NR
Motion Detection	OFF/ON (4 areas, rectangular)
Region of Interest (RoI)	Yes (4 areas)
Image Stabilization	Electronic Image Stabilization (EIS)
Defog	Yes
Image Rotation	Yes
Mirror	Yes
Privacy Masking	8 areas

<b>Audio</b>	
Audio Compression	PCM; G.711a; G.711Mu; G.726; G.723
<b>Alarm</b>	
Alarm Event	No SD card; SD card full; SD card error; network disconnection; IP conflict; illegal access; motion detection; video tampering; intrusion; tripwire; fast moving; abandoned object; missing object; loitering detection; people gathering; parking detection; scene changing; audio detection; voltage detection; defocus detection; external alarm; face detection; people counting in area; stay detection; abnormal number of people detection; people counting; people stay detection; security exception
<b>Network</b>	
Network Port	RJ-45 (10/100/1000 Base-T)
SDK and API	Yes
Network Protocol	IPv4; IPv6; HTTP; TCP; UDP; ARP; RTP; RTSP; RTCP; RTMP; SMTP; FTP; SFTP; DHCP; DNS; DDNS; QoS; UPnP; NTP; Multicast; ICMP; IGMP; NFS; SAMBA; PPPoE; SNMP
Interoperability	ONVIF (Profile S/Profile G/Profile T); CGI; Milestone; P2P
User/Host	20
Storage	FTP; SFTP; Micro SD card (support max. 256 GB); NAS
Browser	IE: IE9 and later Chrome: Chrome 42 and later Firefox: Firefox 48.0.2 and later
Management Software	Smart PSS; DSS; DMSS
Security	Trusted execution; Digest; security logs; WSSE; Account lockout; syslog; 802.1x; IP/MAC filtering; HTTPS; trusted upgrade; trusted boot; generation and importing of X.509 certification
<b>Certification</b>	
Certifications	CE-LVD: EN62368-1; CE-EMC: Electromagnetic Compatibility Directive 2014/30/EU; FCC:47 CFR FCC Part 15, Subpart B; UL/CUL: UL62368-1 & CAN/CSA C22.2 No. 62368-1-14
<b>Port</b>	
RS-485	1 (baud rate range:1200 bps–115200 bps)
Audio Input	1 channel (RCA port)
Audio Output	1 channel (RCA port)
Alarm Input	3 channels in: 5 mA 3–5 VDC
Alarm Output	2 channels out: 300 mA 12 VDC
<b>Power</b>	
Power Supply	12 VDC/PoE+( 802.3at )
Power Consumption	Basic power consumption: 7.4 W (12 VDC); 9.3W (PoE) Max. power consumption (basic + WDR + IR intensity+ lens switch+ power output): 21.3W (12 VDC); 24.7 W (PoE+)
<b>Environment</b>	
Operating Temperature	–30 °C to +60 °C (–22 °F to +140 °F)
Operating Humidity	≤95%
Storage Temperature	–30 °C to +60 °C (–22 °F to +140 °F)
Protection	IP67; IK10; anti-corrosion protection (optional)

Anti-corrosion Level	Moderate Protection(Only supported by -ATC model) *The products feature high-grade anti-corrosion protection, making them well-suited for environments with standard corrosion resistance requirements. They perform reliably from 2 km (1.24 mi) and above in coastal areas and in locations prone to acid rain exposure.
<b>Structure</b>	
Casing Material	Metal + plastic
Product Dimensions	111.3 mm × Φ286.1 mm (4.38"× Φ11.26")
Net Weight	2.75 kg (6.06 lb)
Gross Weight	4.5 kg (9.92 lb)

Ordering Information		
Type	Model	Description
4x5MP Camera	DH-IPC-PDBW82041-B360-S2	4 × 5 MP 4-Directional Panoramic Dome Wizmind Network Camera
	IPC-PDBW82041-B360-S2	4 × 5 MP 4-Directional Panoramic Dome Wizmind Network Camera
Accessories (Optional)	PFB303W	Wall Mount Bracket
	PFB300C	Ceiling Mount Bracket
	PFA111	Mount Adapter
	PFA108	Adapter Plate
	PFM320D	12 VDC 2 A Power Adapter
	PFM900-E	Integrated Mount Tester
	TF-P100	Memory Card

**Accessories**

Optional:



PFB303W  
Wall Mount  
Bracket



PFB300C  
Ceiling Mount  
Bracket



PFA111  
Mount  
Adapter



PFA108  
Adapter Plate



PFM320D  
12 VDC 2 A  
Power Adapter



PFM900-E  
Integrated  
Mount Tester



TF-P100  
MicroSD  
Memory Card

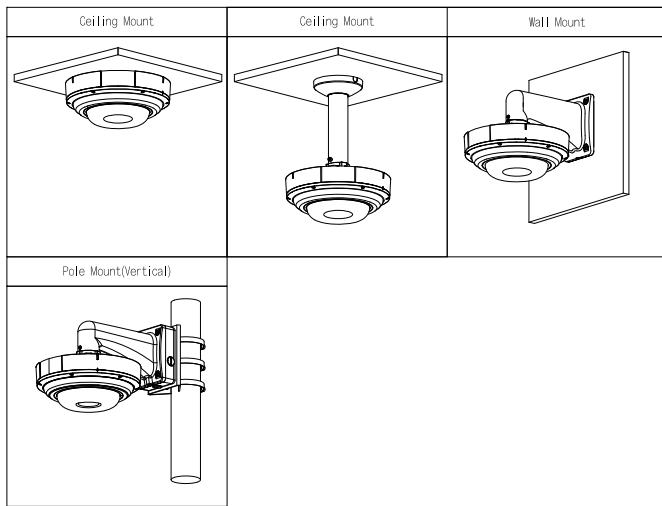

**Dimensions (mm[inch])**

